

# BOREAS LED UFO HIGH BAY LIGHT



## 60W-500W Full Range UFO High Bay Light



150lm/W  
170lm/W  
190lm/W



IP65



IK08



Warranty

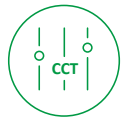

CCT Selectable



Power Selectable



Microwave sensor



Zhaga



RoHS

High Brightness Lumileds LED Chips

- 1. CCT: 3000K/4000K/5000K/5700K/6500K
- 2. Lumen Efficiency: 150lm/W, 170lm/W, 190lm/W
- 3. CRI: Ra>80
- 4. Lifetime: 50,000Hrs@L70

PHILIPS or SOSEN Driver

**PHILIPS** DRIVER  
**SOSEN** DRIVER

3CCT & Power Selectable



For ZHAGA or Sensor

- 1. Zhaga Socket
- 2. Microwave Sensor

High Strength Polycarbonate Lens

- 1. Beam angle options : 60/90/110°
- 2. IK 08

Aluminum Housing

Die-cast technology with ADC12  
excellent thermal management

## 150lm/W CRI>80, and 170lm/W, 190lm/W Options



60W



100W



150W



200W/240W



300W



400W/500W

# CCT & POWER Adjustable

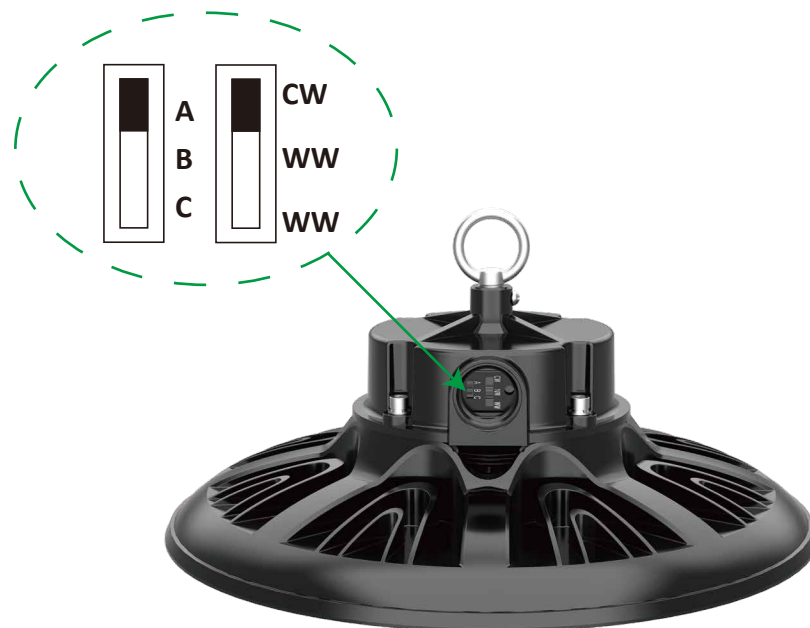

A	B	C
100W	80W	60W
150W	120W	100W
200W	150W	100W
240W	200W	150W
300W	240W	200W
500W	400W	300W
WW	NW	CW
4000K	5000K	5700K

## Specifications

Model No	LGS-UFOB-60W	LGS-UFOB-100W	LGS-UFOB-150W	LGS-UFOB-200W	LGS-UFOB-240W	LGS-UFOB-300W	LGS-UFOB-400W	LGS-UFOB-500W
Power	60W	100W	150W	200W	240W	300W	400W	500W
Input Voltage	AC100-277V,50/60HZ							
Lumen EFF.	150lm/W,170lm/W,190lm/W							
Lumen Flux(±5%)	9,000LM	15,000LM	22,500LM	30,000LM	36,000LM	45,000LM	60,000LM	75,000LM
	10,200LM	17,000LM	25,500LM	34,000LM	40,800LM	51,000LM	68,000LM	85,000LM
	11,400LM	19,000LM	28,500LM	38,000LM	45,600LM	57,000LM	76,000LM	95,000LM
QTY of LEDs	130PCS/ 172PCS	208PCS/300 PCS	300PCS/450PCS	420PCS/680PCS	420PCS/680PCS	616PCS/935PCS	1100PCS/1530PCS	1100PCS/1530PCS
LED Brand	LUMILEDS 2835 /SAN'AN 2835							
Driver Brand	SOSEN or PHILIPS						MOSO	
CCT	3000K,4000K,5000K,5700K,6500K and 3CCT ADJ							
CRI	>80							
PF	>95							
Beam Angle	60°/90°/120°						40°/60°/90°	
IP Rating	IP65							
IK Rating	IK08							
Warranty	5-year@SOSEN & MOSO, 7-year@PHILIPS							
Dimmension(mm)	233*145	260*145	287*147	305*149	305*149	342*168	447*178	447*178



# Photometry

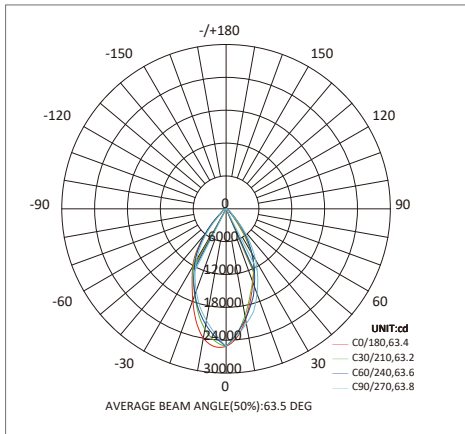
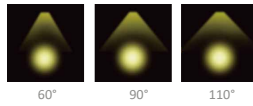

90°

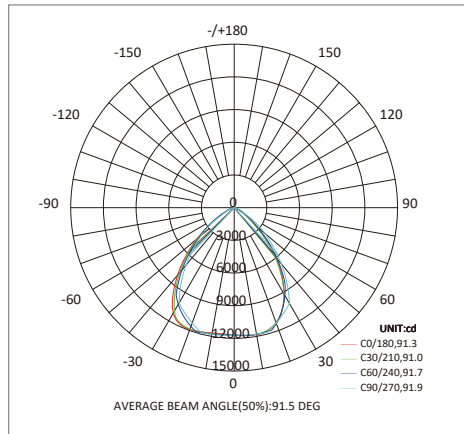

60°

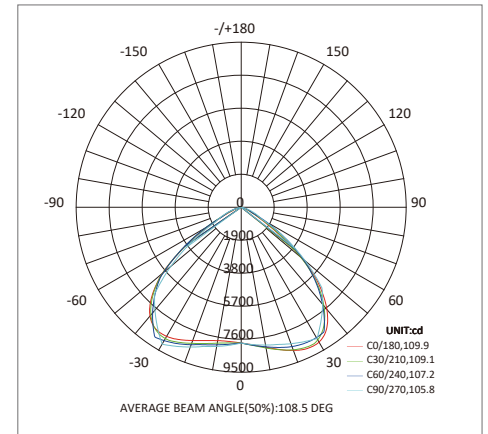

110°

# Dimensions

01 LGS-UFOB-60W

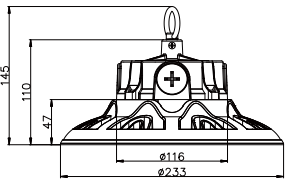

02 LGS-UFOB-100W

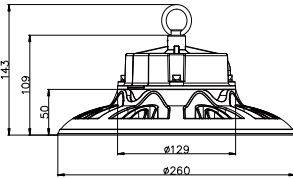

03 LGS-UFOB-150W

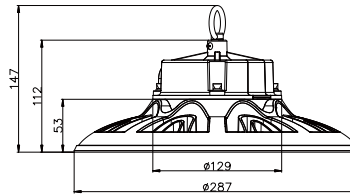

04 LGS-UFOB-200W/240W

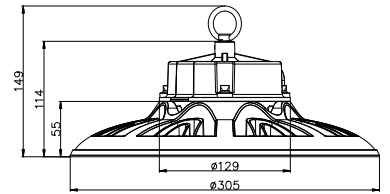

05 LGS-UFOB-300W

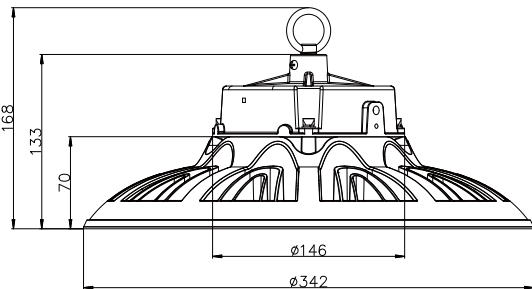

06 LGS-UFOB-400W/500W

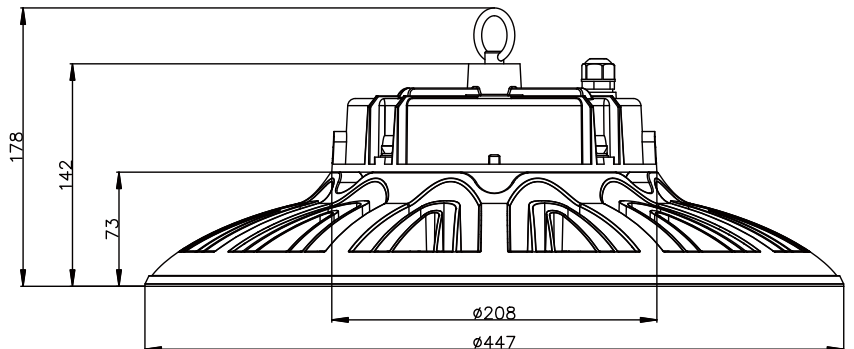

# Spare Part Options



Zhaga Socket



Microwave Sensor



Alu Reflector



U Bracket



Safety Steel Rope